



金新工業股份有限公司
CHEN'S CONTAINER INDUSTRIAL CORP.

真空壓空成型 ■ 專業製造廠



OPS高級食品包裝容器
OPS食品專用內襯
PP生鮮冷凍托盤
PP可微波餐盤
PET · PS · PP · OPS · PLA

**FOOD
PACKAGING**



- 01** 關於金新 About CCI
公司簡介 · 歷史沿革 · 願景與優勢
- 06** 沙拉碗 Salad Bowl Series
- 08** 對折盒 Hinged Container Series
- 09** 醬料杯 Portion Cup Series
- 10** 杯子與杯蓋 Cold Cup Series
- 12** 外帶餐盒 Take-Out Container
- 18** 蔬果盒 Fruit Container



- 21** 西點盒 Dessert Container
- 24** 托盤 Supermarket Tray
- 27** 多用途容器 Multi-Container
- 28** 食品盒 Food Container
- 30** 底襯 Underlay
- 31** 蛋盒 Egg Container

**ENDLESS
INNOVATION**



關於金新

About CCI

歷史沿革 / History

Established in 1991, CCI is a manufacturer specializing in the design and production of disposable plastic packaging. The products include Take-out Containers, Food Boxes, Fruit Containers, Cold Cups... etc. CCI has accumulated considerable experience over the years, and continuous research, development and innovation to serve and meet customer's requirement.

CCI has been certificated by ISO22000:2018, HACCP, BPI and Din Certco. The material that we produce including regular PP, PLA, PET, RPET and PS. In processes, from sheet extrusion to thermoforming, all steps are made in house. We follow quality control procedures in all production stages. We provide diversified choices to customers, and also through improving the quality of food packaging, solutions and professional and reliable services. CCI has established an excellent industry standard.

金新公司成立於 1991 年，專業設計生產一次性使用之塑料包裝的製造廠商，生產的產品包含外帶餐盒、食品盒、蔬果盒、飲料杯...等等，多年來累積了相當豐富的經驗，並以不斷研發創新來服務及滿足客戶需求。

金新公司已通過國內 ISO22000:2018 和 HACCP 認證，亦擁有 BPI 和 Din Certco 證書。我們在所有生產階段都遵循質量控製程序，所生產的產品包含各類型的材質，PET、PP、PS 和 PLA，由皮料板材押出、成型生產到成品出貨均採一貫作業，提供給客人多樣化的選擇，並通過提高食品包裝的質量、解決方案和專業可靠的服務，樹立了卓越的行業標準。

認證證書 / Certification



PRODUCTION MANAGEMENT, QUALITY, SAFETY, EFFICIENCY, COOPERATION

品質 · 安全 · 效率 · 配合度

金新公司提供給客戶高質量的包材。
CCI provides high-quality packaging products for customers.

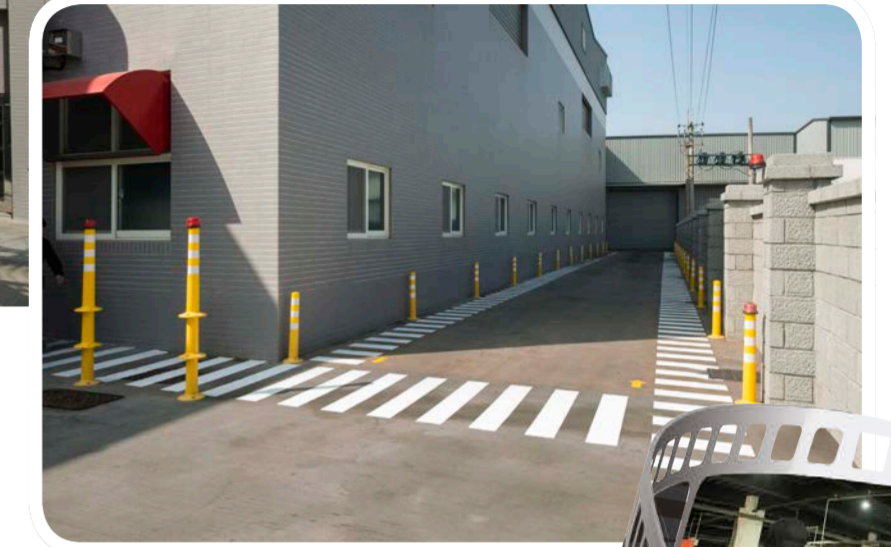

VISION AND ADVANTAGES

願景與優勢

以豐富的經驗和專業知識來幫助客人創建所需的包材，滿足市場需求。

With professional experience to help customers create excellent packaging products for markets.

MANAGEMENT PHILOSOPHY

營運方針



Customization

客製化

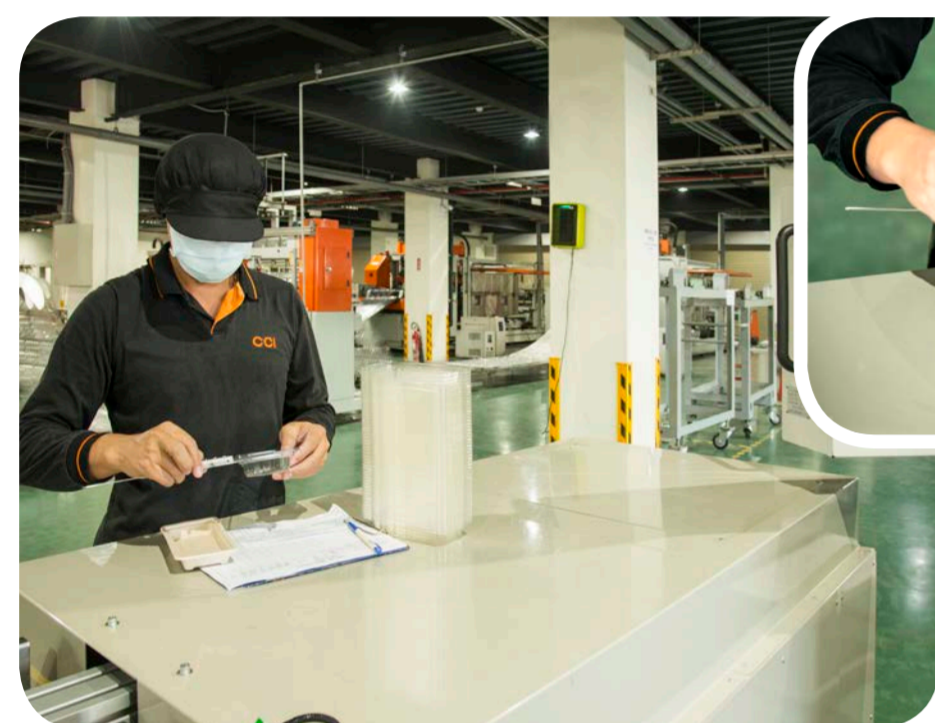

Quality

品質控管



Competitive

競爭力



Price

物超所值



HEALTHY DELICIOUS SALAD



FSC-18

材質 Material : PLA, PET
尺寸 Size : Ø175x48.5mm
數量 Quantity : 200sets
材積 Cu.ft. : 2.69'



FSC-24

材質 Material : PLA, PET
尺寸 Size : Ø175x59mm
數量 Quantity : 200sets
材積 Cu.ft. : 2.74'



FSC-32

材質 Material : PLA, PET
尺寸 Size : Ø175x81mm
數量 Quantity : 200sets
材積 Cu.ft. : 2.84'



FSC-40

材質 Material : PLA, PET
尺寸 Size : Ø175x95mm
數量 Quantity : 200sets
材積 Cu.ft. : 2.91'



FSC-48

材質 Material : PLA, PET
尺寸 Size : Ø175x113mm
數量 Quantity : 200sets
材積 Cu.ft. : 3.00'



KF-009

材質 Material : PET
尺寸 Size : Ø155x77mm
數量 Quantity : 500sets
材積 Cu.ft. : 4.20'



B400

材質 Material : OPS, PET
尺寸 Size : Ø143x59mm
數量 Quantity : 1200/1200pcs
材積 Cu.ft. : 3.38/ 1.49'



B500

材質 Material : OPS, PET
尺寸 Size : Ø156x73mm
數量 Quantity : 900/900pcs
材積 Cu.ft. : 4.17/ 2.07'



HINGED CONTAINER SERIES

對折盒



HSD-8
 材質 Material : PLA, PET
 尺寸 Size : 124x106x52mm
 數量 Quantity : 300pcs
 材積 Cu.ft. : 1.86'



HSD-12
 材質 Material : PLA, PET
 尺寸 Size : 142x125x54mm
 數量 Quantity : 300pcs
 材積 Cu.ft. : 2.5'



HSD-16
 材質 Material : PLA, PET
 尺寸 Size : 142x125x67mm
 數量 Quantity : 300pcs
 材積 Cu.ft. : 2.54'



HSD-24
 材質 Material : PLA, PET
 尺寸 Size : 165x148x63mm
 數量 Quantity : 200pcs
 材積 Cu.ft. : 2.32'



HSD-32
 材質 Material : PLA, PET
 尺寸 Size : 186x168x66mm
 數量 Quantity : 200pcs
 材積 Cu.ft. : 2.90'



HSD-48
 材質 Material : PLA, PET
 尺寸 Size : 201x181x76mm
 數量 Quantity : 200pcs
 材積 Cu.ft. : 3.34'



PORTION CUP SERIES

醬料杯

www.ccicorp.com.tw



PL-70
 材質 Material : PLA, PET
 尺寸 Size : Ø70x6mm
 容量 Quantity : 2000pcs
 材積 Cu.ft. : 1.54'

PC-2
 容量 Capacity : 2oz
 材質 Material : PLA, PET
 尺寸 Size : Ø70x26mm
 容量 Quantity : 2000pcs
 材積 Cu.ft. : 0.95'

PC-3
 容量 Capacity : 3oz
 材質 Material : PLA, PET
 尺寸 Size : Ø70x40mm
 容量 Quantity : 2000pcs
 材積 Cu.ft. : 1.1'

PC-4
 容量 Capacity : 4oz
 材質 Material : PLA, PET
 尺寸 Size : Ø70x47mm
 容量 Quantity : 2000pcs
 材積 Cu.ft. : 1.47'

C180L
 材質 Material : PLA, PET
 尺寸 Size : Ø103x7mm
 容量 Quantity : 2500, 1000pcs
 材積 Cu.ft. : 5.07', 2.11'

C180
 容量 Capacity : 6oz
 材質 Material : PLA, PET
 尺寸 Size : Ø100x40mm
 容量 Quantity : 2500pcs
 材積 Cu.ft. : 6.79'

250MB
 容量 Capacity : 8oz
 材質 Material : PLA, PET
 尺寸 Size : Ø100x60mm
 容量 Quantity : 1000pcs
 材積 Cu.ft. : 2.42'

COLD CUP SERIES

冷飲杯



A Sweet
Cup
Understands
You.



C-9

材質 Material : PLA, PET
尺寸 Size : Ø96x73mm
數量 Quantity : 1000pcs
材積 Cu.ft. : 2.54'



C-12/14

材質 Material : PLA, PET
尺寸 Size : Ø96x106mm
數量 Quantity : 1000pcs
材積 Cu.ft. : 2.65'



C-16

材質 Material : PLA, PET
尺寸 Size : Ø96x124mm
數量 Quantity : 1000pcs
材積 Cu.ft. : 3.39'



C-20

材質 Material : PLA, PET
尺寸 Size : Ø96x143mm
數量 Quantity : 1000pcs
材積 Cu.ft. : 3.67'



C-24/22

材質 Material : PLA, PET
尺寸 Size : Ø96x152mm
數量 Quantity : 1000pcs
材積 Cu.ft. : 3.78'



IC-4

材質 Material : PLA, PET
尺寸 Size : Ø89x30mm
數量 Quantity : 2000pcs
材積 Cu.ft. : 2.28'

COLD CUP LID

杯蓋



A-96FL

材質 Material : PLA, PET
尺寸 Size : Ø100x8mm
數量 Quantity : 1000pcs
材積 Cu.ft. : 2.00'



A-96DL

材質 Material : PLA, PET
尺寸 Size : Ø100x46mm
數量 Quantity : 1000pcs
材積 Cu.ft. : 2.27'



A-96SL

材質 Material : PLA, PET
尺寸 Size : Ø100x21mm
數量 Quantity : 1000pcs
材積 Cu.ft. : 2.20'

TAKE-OUT CONTAINER SERIES 外帶餐盒



B700

容量 Capacity : 700ml
材質 Material : PET, OPS/PP
尺寸 Size : Ø185x60mm
數量 Quantity : 500/500pcs
材積 Cu.ft. : 4.09/ 4.44'



B700-35

容量 Capacity : 500ml
材質 Material : PET, OPS/PP
尺寸 Size : Ø185x45mm
數量 Quantity : 200sets
材積 Cu.ft. : 3.08'



B700-60

容量 Capacity : 1000ml
材質 Material : PET, OPS/PP
尺寸 Size : Ø185x70mm
數量 Quantity : 200sets
材積 Cu.ft. : 3.21'



TAKE-OUT CONTAINER SERIES 外帶餐盒



LJ-0.4

材質 Material : OPS/PS, PLA
尺寸 Size : 169x93x43mm
數量 Quantity : 500sets
材積 Cu.ft. : 1.87'



LJ-0.6

材質 Material : OPS/PS, PLA
尺寸 Size : 224x100x43mm
數量 Quantity : 500sets
材積 Cu.ft. : 2.59'



LJ-0.8

材質 Material : OPS/PS, PLA
尺寸 Size : 167x116x48mm
數量 Quantity : 500sets
材積 Cu.ft. : 2.51'



LJ-1.0

材質 Material : OPS/PS, PLA
尺寸 Size : 190x132x43mm
數量 Quantity : 500sets
材積 Cu.ft. : 2.97'



LJ-1.5

材質 Material : OPS/PS, PLA
尺寸 Size : 216x135x43mm
數量 Quantity : 500sets
材積 Cu.ft. : 3.28'



LJ-2.5

材質 Material : OPS/PS, PLA
尺寸 Size : 272x203x50mm
數量 Quantity : 300sets
材積 Cu.ft. : 3.90'



C-008

材質 Material : OPS/PP
尺寸 Size : 235x175x60mm
數量 Quantity : 200sets
材積 Cu.ft. : 3.10'



C-012

材質 Material : OPS/PP
尺寸 Size : 275x175x60mm
數量 Quantity : 200sets
材積 Cu.ft. : 3.35'



C-016

材質 Material : OPS/PP
尺寸 Size : 408x175x62mm
數量 Quantity : 200/200pcs
材積 Cu.ft. : 2.45/2.51'

TAKE-OUT CONTAINER SERIES 外帶餐盒



C-123-1

材質 Material : OPS/PP
 尺寸 Size : 235x200x72mm
 數量 Quantity : 250sets
 材積 Cu.ft. : 5.36'



C-123-2

材質 Material : OPS/PP
 尺寸 Size : 235x200x72mm
 數量 Quantity : 250sets
 材積 Cu.ft. : 5.36'



C-123-3

材質 Material : OPS/PP
 尺寸 Size : 235x200x72mm
 數量 Quantity : 250sets
 材積 Cu.ft. : 5.36'



B800

材質 Material : OPS/PP
 尺寸 Size : 188x130x46mm
 數量 Quantity : 600sets
 材積 Cu.ft. : 4.75'



B-38

材質 Material : OPS/PP
 尺寸 Size : 203x143x50mm
 數量 Quantity : 900/900pcs
 材積 Cu.ft. : 5.28/4.67'



C-101

材質 Material : OPS/PP
 尺寸 Size : 215x147x52mm
 數量 Quantity : 600/600pcs
 材積 Cu.ft. : 1.02/4.44'



C-201

材質 Material : OPS/PP
 尺寸 Size : 215x147x47mm
 數量 Quantity : 600/600pcs
 材積 Cu.ft. : 1.02/4.44'



C-401

材質 Material : OPS/PP
 尺寸 Size : 233x187x51mm
 數量 Quantity : 500/500pcs
 材積 Cu.ft. : 2.32/1.56'



C-8511L

材質 Material : PP
 尺寸 Size : Ø155x10mm
 容量 Quantity : 600pcs
 材積 Cu.ft. : 3.32'



C-501

材質 Material : OPS/PP
 尺寸 Size : 240x193x55mm
 容量 Quantity : 500/500pcs
 材積 Cu.ft. : 3.25/2.96'



C-502

材質 Material : OPS/PP
 尺寸 Size : 267x202x45mm
 容量 Quantity : 400/400pcs
 材積 Cu.ft. : 1.15/5.17'



C-104-40

材質 Material : PP
 尺寸 Size : 188x124x40mm
 容量 Quantity : 600pcs
 材積 Cu.ft. : 3.86'



www.ccicorp.com.tw

TAKE-OUT CONTAINER SERIES 外帶餐盒



C-102L

材質 Material : PET
 尺寸 Size : 193x137x13mm
 容量 Quantity : 600pcs
 材積 Cu.ft. : 3.79'



C-102B-25

材質 Material : PP
 尺寸 Size : 188x133x25mm
 容量 Quantity : 1200pcs
 材積 Cu.ft. : 3.4'



C-102B-45

材質 Material : PP
 尺寸 Size : 188x133x45mm
 容量 Quantity : 1200pcs
 材積 Cu.ft. : 4.14'



C-102B-65

材質 Material : PP
 尺寸 Size : 188x133x65mm
 容量 Quantity : 900pcs
 材積 Cu.ft. : 3.67'



C-103B-35

材質 Material : PP
 尺寸 Size : 224x174x35mm
 容量 Quantity : 480pcs
 材積 Cu.ft. : 3.95'



C-103B-45

材質 Material : PP
 尺寸 Size : 230x173x43mm
 容量 Quantity : 600pcs
 材積 Cu.ft. : 5.7'



C-103B-60

材質 Material : PP
 尺寸 Size : 230x173x60mm
 容量 Quantity : 600pcs
 材積 Cu.ft. : 5.52'

TAKE-OUT CONTAINER SERIES 外帶餐盒

**C-015**

容量 Capacity : 1500ml
 材質 Material : PP/PP
 尺寸 Size : 216x199x92mm
 容量 Quantity : 300/300pcs
 材積 Cu.ft. : 3.85/5.97'

**C-001
FLAT 平蓋**

容量 Capacity : 2000ml
 材質 Material : PP/PP
 尺寸 Size : 243x221x106mm
 容量 Quantity : 300/300pcs
 材積 Cu.ft. : 5.81/6.92'

**C-001
DOME 凸蓋**

容量 Capacity : 2000ml
 材質 Material : PP/PP
 尺寸 Size : 243x221x134mm
 容量 Quantity : 300/300pcs
 材積 Cu.ft. : 6.52/6.92'

**C-011**

容量 Capacity : 3000ml
 材質 Material : PP/PP
 尺寸 Size : 268x235x126mm
 容量 Quantity : 200/200pcs
 材積 Cu.ft. : 4.98/6.92'

**C-011-4**

容量 Capacity : 4000ml
 材質 Material : PP/PP
 尺寸 Size : 296x268x110mm
 容量 Quantity : 200/200pcs
 材積 Cu.ft. : 4.43/7.20'

**C-011-5**

容量 Capacity : 5000ml
 材質 Material : PP/PP
 尺寸 Size : 335x310x133mm
 容量 Quantity : 100/50pcs
 材積 Cu.ft. : 3.04/2.63'

**C-200-3
(PET LID)**

材質 Material : PET/PP
 尺寸 Size : Ø240x64mm
 容量 Quantity : 300/300pcs
 材積 Cu.ft. : 3.18/5.77'

**C-200-3
(PP LID)**

材質 Material : PP/PP
 尺寸 Size : Ø240x64mm
 容量 Quantity : 300/300pcs
 材積 Cu.ft. : 4.41/5.77'

**C-200-5
(PET LID)**

材質 Material : PET/PP
 尺寸 Size : Ø265x80mm
 容量 Quantity : 300/300pcs
 材積 Cu.ft. : 2.59/6.1'

**C-200-5
(PP LID)**

材質 Material : PP/PP
 尺寸 Size : Ø265x80mm
 容量 Quantity : 300/300pcs
 材積 Cu.ft. : 6.1/6.1'

**C-200-6**

材質 Material : PP/PP
 尺寸 Size : Ø307x80mm
 容量 Quantity : 200/200pcs
 材積 Cu.ft. : 5.44/6.33'

**C-200-6B2**

材質 Material : PP/PP
 尺寸 Size : Ø307x52mm
 容量 Quantity : 200/200pcs
 材積 Cu.ft. : 5.44/6.33'

**C3-4**

材質 Material : PET/PP
 尺寸 Size : Ø256x47mm
 容量 Quantity : 200/200pcs
 材積 Cu.ft. : 2.37/3.45'

**C5-6**

材質 Material : PET/PP
 尺寸 Size : Ø256x47mm
 容量 Quantity : 200/200pcs
 材積 Cu.ft. : 2.37/3.45'

**C-006**

材質 Material : PET/PP
 尺寸 Size : 343x208x65mm
 容量 Quantity : 300/300pcs
 材積 Cu.ft. : 5.08/5.24'

**C-018**

材質 Material : PP/PP
 尺寸 Size : 385x242x58mm
 容量 Quantity : 200/200pcs
 材積 Cu.ft. : 3.45/4.83'

FRUIT CONTAINER SERIES 蔬果盒



FRUIT CONTAINER SERIES 蔬果盒

**1QT**

材質 Material : PET, PLA
尺寸 Size : 188x113x83mm
數量 Quantity : 400, 360pcs
材積 Cu.ft. : 2.89'

**1/2QT**

材質 Material : PET, PLA
尺寸 Size : 190x120x60mm
數量 Quantity : 400pcs
材積 Cu.ft. : 2.65'

**1/4QT**

材質 Material : PET, PLA
尺寸 Size : 190x120x42mm
數量 Quantity : 800pcs
材積 Cu.ft. : 4.77'

**1/8QT**

材質 Material : PET, PLA
尺寸 Size : 166x112x40mm
數量 Quantity : 600pcs
材積 Cu.ft. : 3.02'

**1 PINT**

材質 Material : PET, PLA
尺寸 Size : 111x129x64mm
數量 Quantity : 600pcs
材積 Cu.ft. : 4.16'

**5040-300**

材質 Material : PET, PLA
尺寸 Size : 111x130x70mm
數量 Quantity : 600pcs
材積 Cu.ft. : 4.16'

**A-005**

材質 Material : PET, PLA
尺寸 Size : 300x110x87mm
數量 Quantity : 400pcs
材積 Cu.ft. : 3.99'

**466**

材質 Material : PET, PLA
尺寸 Size : 163x163x65mm
數量 Quantity : 600pcs
材積 Cu.ft. : 4.06'

**A-018**

材質 Material : PET, PLA
尺寸 Size : 224x175x58mm
數量 Quantity : 300pcs
材積 Cu.ft. : 3.34'

**A-011(KF-011)**

材質 Material : PET, PLA
尺寸 Size : 224x121x98mm
數量 Quantity : 500pcs
材積 Cu.ft. : 4.18'

**A-011-2**

材質 Material : PET, PLA
尺寸 Size : 213x122x98mm
數量 Quantity : 500pcs
材積 Cu.ft. : 4.52'

**LJ-010**

材質 Material : PET, PLA
尺寸 Size : 176x124x72mm
數量 Quantity : 500pcs
材積 Cu.ft. : 2.82'

**5040-125**

材質 Material : PET, PLA
尺寸 Size : 127x112x48mm
數量 Quantity : 600pcs
材積 Cu.ft. : 4.03'

**A-003S**

材質 Material : PET, PLA
尺寸 Size : 183x125x87mm
數量 Quantity : 400,600pcs
材積 Cu.ft. : 2.70',4.50'

**KF-003**

材質 Material : PET, PLA
尺寸 Size : 184x125x89mm
數量 Quantity : 1000,600pcs
材積 Cu.ft. : 6.73',4.50'

**KF-017**

材質 Material : PET, PLA
尺寸 Size : 143x127x69mm
數量 Quantity : 800pcs
材積 Cu.ft. : 5.64'

**A-006(KW-T6)**

材質 Material : PET, PLA, OPS
尺寸 Size : 179x168x59mm
數量 Quantity : 800, 1000pcs
材積 Cu.ft. : 3.51'

**A-008**

材質 Material : PET, PLA
尺寸 Size : 163x123x73mm
數量 Quantity : 600pcs
材積 Cu.ft. : 4.25'

FRUIT CONTAINER SERIES 蔬果盒



A-02B

材質 Material : PET, PLA
尺寸 Size : 176x129x71mm
數量 Quantity : 500pcs
材積 Cu.ft. : 2.93'



A-1418

材質 Material : PET, PLA
尺寸 Size : 184x143x80mm
數量 Quantity : 1000,400pcs
材積 Cu.ft. : 5.72',3.06'



A-21

材質 Material : PET, PLA
尺寸 Size : 219x119x98mm
數量 Quantity : 500pcs
材積 Cu.ft. : 4.01'



A-22

材質 Material : PET, PLA
尺寸 Size : 240x144x98mm
數量 Quantity : 500pcs
材積 Cu.ft. : 5.40'



A-200

材質 Material : PET, PLA
尺寸 Size : 194x162x84mm
數量 Quantity : 300pcs
材積 Cu.ft. : 3.49'



A-300

材質 Material : PET, PLA
尺寸 Size : 178x119x52mm
數量 Quantity : 500pcs
材積 Cu.ft. : 5.64'



A-550

材質 Material : PET, PLA
尺寸 Size : 179x137x77mm
數量 Quantity : 400pcs
材積 Cu.ft. : 4.67'



A-6363

材質 Material : PET, PLA
尺寸 Size : 155x159x76mm
數量 Quantity : 400pcs
材積 Cu.ft. : 3.36'



A-850

材質 Material : PET
尺寸 Size : 175x174x90mm
數量 Quantity : 300pcs
材積 Cu.ft. : 5.20'



A-9474

材質 Material : PET, PLA
尺寸 Size : 237x188x84mm
數量 Quantity : 250, 300pcs
材積 Cu.ft. : 3.63'



Grape Container(大葡萄盒)

材質 Material : PET, PLA
尺寸 Size : 260x161x91mm
數量 Quantity : 300pcs
材積 Cu.ft. : 3.87'

DESSERT CONTAINER SERIES 西點盒



V2

材質 Material : OPS, PLA
尺寸 Size : 188x203x55mm
數量 Quantity : 350pcs
材積 Cu.ft. : 2.58'



V3

材質 Material : OPS, PLA, PET
尺寸 Size : 188x204x44mm
數量 Quantity : 350pcs
材積 Cu.ft. : 2.58'

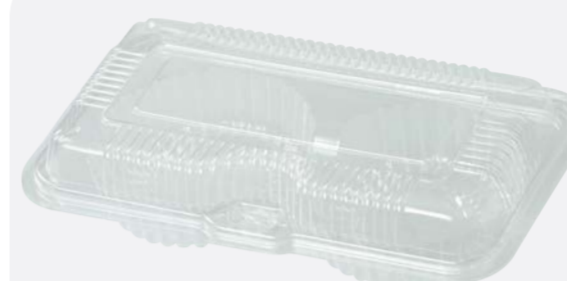

V4

材質 Material : OPS, PLA
尺寸 Size : 188x110x44mm
數量 Quantity : 2000pcs
材積 Cu.ft. : 4.52'



V5

材質 Material : OPS, PLA
尺寸 Size : Ø246x80mm
數量 Quantity : 450,300pcs
材積 Cu.ft. : 5.30', 4.36'



V6S

材質 Material : PET
尺寸 Size : Ø187x75mm
數量 Quantity : 450pcs
材積 Cu.ft. : 3.52'

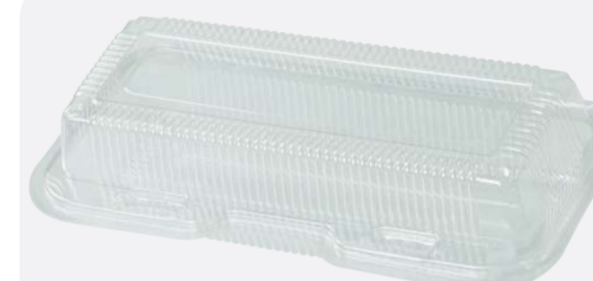

V7

材質 Material : OPS, PLA
尺寸 Size : 241x120x59mm
數量 Quantity : 1200pcs
材積 Cu.ft. : 4.56'



V8S

材質 Material : OPS, PLA, PET
尺寸 Size : 173x160x73mm
數量 Quantity : 800pcs
材積 Cu.ft. : 3.86'



V12

材質 Material : OPS, PLA
尺寸 Size : 283x194x33mm
數量 Quantity : 300pcs
材積 Cu.ft. : 2.41',3.02'



V301-1

材質 Material : OPS, PLA
尺寸 Size : 203x125x69mm
數量 Quantity : 1200pcs
材積 Cu.ft. : 4.93'



V200

材質 Material : OPS, PLA
尺寸 Size : 265x263x91mm
數量 Quantity : 250pcs
材積 Cu.ft. : 2.64'



V200-1

材質 Material : OPS, PLA
尺寸 Size : 238x238x95mm
數量 Quantity : 250pcs
材積 Cu.ft. : 2.76'



V300

材質 Material : OPS, PLA
尺寸 Size : 231x242x59mm
數量 Quantity : 500, 300pcs
材積 Cu.ft. : 4.31', 2.15'



V300-1

材質 Material : OPS, PLA
尺寸 Size : 231x242x76mm
數量 Quantity : 500, 300pcs
材積 Cu.ft. : 4.31', 2.15'

DESSERT CONTAINER SERIES 西點盒

**V400**

材質 Material : OPS
尺寸 Size : 205x212x80mm
數量 Quantity : 500pcs
材積 Cu.ft. : 4.25'

**V500**

材質 Material : OPS, PLA, PET
尺寸 Size : 177x178x81mm
數量 Quantity : 400pcs
材積 Cu.ft. : 3.40'

**AC-315**

材質 Material : OPS, PLA
尺寸 Size : 155x105x70mm
數量 Quantity : 3000, 1200pcs
材積 Cu.ft. : 11.23', 4.56'

**AC-333**

材質 Material : OPS, PLA
尺寸 Size : 242x118x80mm
數量 Quantity : 1200, 1200pcs
材積 Cu.ft. : 7.52', 8.15'

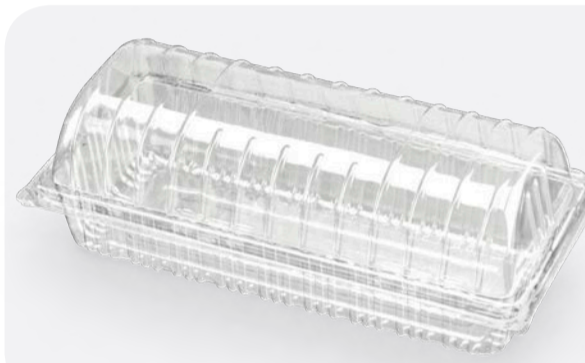
**AC-333S**

材質 Material : PET, PLA
尺寸 Size : 235x115x80mm
數量 Quantity : 1200pcs
材積 Cu.ft. : 6.70'

**B315**

材質 Material : OPS, PLA
尺寸 Size : 158x101x73mm
數量 Quantity : 3000pcs
材積 Cu.ft. : 7.45'

**B326**

材質 Material : OPS, PLA, PET
尺寸 Size : 182x102x67mm
數量 Quantity : 2000pcs
材積 Cu.ft. : 7.06'

**B333**

材質 Material : OPS, PLA, PET
尺寸 Size : 245x120x80mm
數量 Quantity : 1200pcs
材積 Cu.ft. : 5.55'

**CCI-109**

材質 Material : PET, PLA
尺寸 Size : 212x216x76mm
數量 Quantity : 250pcs
材積 Cu.ft. : 3.03'

**S2**

材質 Material : OPS
尺寸 Size : 212x98x29mm
數量 Quantity : 1000pcs
材積 Cu.ft. : 1.77'

**K313**

材質 Material : OPS, PLA
尺寸 Size : 212x90x38mm
數量 Quantity : 2000, 1200pcs
材積 Cu.ft. : 7.39', 4.85'

**K319**

材質 Material : OPS, PLA
尺寸 Size : 238x107x68mm
數量 Quantity : 1200pcs
材積 Cu.ft. : 5.82'

**K321**

材質 Material : OPS, PLA
尺寸 Size : 200x204x64mm
數量 Quantity : 500pcs
材積 Cu.ft. : 3.63'

DESSERT CONTAINER SERIES 西點盒

**S11**

材質 Material : OPS
尺寸 Size : 142x147x66mm
數量 Quantity : 1000pcs
材積 Cu.ft. : 2.03'

**S14**

材質 Material : OPS
尺寸 Size : 174x107x68mm
數量 Quantity : 2000pcs
材積 Cu.ft. : 2.80'

**S17**

材質 Material : OPS, PLA
尺寸 Size : 132x150x73mm
數量 Quantity : 1200, 500pcs
材積 Cu.ft. : 3.88', 1.76'

**S31**

材質 Material : OPS
尺寸 Size : 124x102x37mm
數量 Quantity : 2000pcs
材積 Cu.ft. : 1.65'

**S327C**

材質 Material : OPS, PLA
尺寸 Size : 184x95x57mm
數量 Quantity : 2000pcs
材積 Cu.ft. : 7.03'

**S32C**

材質 Material : OPS, PLA
尺寸 Size : 129x98x60mm
數量 Quantity : 2000pcs
材積 Cu.ft. : 4.42'

**S34**

材質 Material : PET, PLA
尺寸 Size : 145x155x45mm
數量 Quantity : 1000pcs
材積 Cu.ft. : 5.48'

**S36C**

材質 Material : OPS
尺寸 Size : 108x143x73mm
數量 Quantity : 3000pcs
材積 Cu.ft. : 7.96'

**S61C**

材質 Material : OPS, PLA
尺寸 Size : 98x95x43mm
數量 Quantity : 2400pcs
材積 Cu.ft. : 4.32'

**S704**

材質 Material : OPS
尺寸 Size : 153x124x51mm
數量 Quantity : 1600pcs
材積 Cu.ft. : 2.85'

**B-106**

材質 Material : PET/PS
尺寸 Size : Ø217x90mm
數量 Quantity : 600/600pcs
材積 Cu.ft. : 6.99' / 5.18'

**K72**

材質 Material : PET/PS
尺寸 Size : 236x139x98mm
數量 Quantity : 500sets
材積 Cu.ft. : 7.69'

**K73**

材質 Material : PET/PS
尺寸 Size : 236x139x98mm
數量 Quantity : 500sets
材積 Cu.ft. : 7.71'

SUPERMARKET TRAY 托盤



SUPERMARKET TRAY 托盤

**7" Tray**

材質 Material : PS, PLA
尺寸 Size : Ø188x13mm
數量 Quantity : 1000pcs
材積 Cu.ft. : 1.70'

**9" Tray**

材質 Material : PS, PLA, PP
尺寸 Size : Ø229x16mm
數量 Quantity : 400pcs
材積 Cu.ft. : 1.16'

**C-09**

材質 Material : PP
尺寸 Size : Ø228x22mm
數量 Quantity : 300pcs
材積 Cu.ft. : 1.23'

**10" Tray**

材質 Material : PS, PLA
尺寸 Size : Ø260x22mm
數量 Quantity : 500pcs
材積 Cu.ft. : 2.07'

**10"-3P Tray**

材質 Material : PS, PLA
尺寸 Size : Ø260x22mm
數量 Quantity : 400pcs
材積 Cu.ft. : 1.63'

**02S**

材質 Material : PLA
尺寸 Size : 172x101x18mm
數量 Quantity : 2000pcs
材積 Cu.ft. : 1.5'

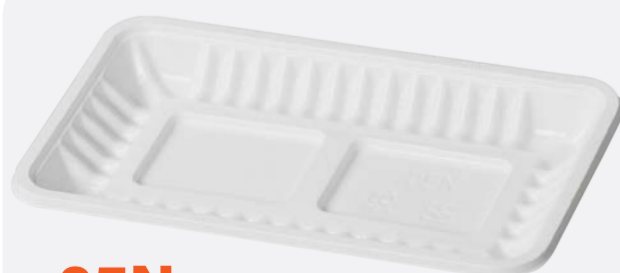
**05N**

材質 Material : PLA
尺寸 Size : 197x113x20mm
數量 Quantity : 1000pcs
材積 Cu.ft. : 0.97'

**1**

材質 Material : PLA
尺寸 Size : 140x84x16mm
數量 Quantity : 2000pcs
材積 Cu.ft. : 1.01'

**2**

材質 Material : PLA
尺寸 Size : 169x105x18mm
數量 Quantity : 1000pcs
材積 Cu.ft. : 0.76'

**3**

材質 Material : PLA
尺寸 Size : 139x139x15mm
數量 Quantity : 2000pcs
材積 Cu.ft. : 1.58'

**5**

材質 Material : PLA
尺寸 Size : 197x114x13mm
數量 Quantity : 1000pcs
材積 Cu.ft. : 0.97'

**7**

材質 Material : PLA, PET
尺寸 Size : 245x105x14mm
數量 Quantity : 1200pcs
材積 Cu.ft. : 1.32'

**8**

材質 Material : PLA
尺寸 Size : 305x103x14mm
數量 Quantity : 1000pcs
材積 Cu.ft. : 1.60'

**9**

材質 Material : PLA, PET
尺寸 Size : 294x114x16mm
數量 Quantity : 1000pcs
材積 Cu.ft. : 2.05'

**10**

材質 Material : PLA, PET
尺寸 Size : 330x106x22mm
數量 Quantity : 800pcs
材積 Cu.ft. : 1.55'

**11**

材質 Material : PLA
尺寸 Size : 148x148x14mm
數量 Quantity : 2000pcs
材積 Cu.ft. : 1.43'

**12**

材質 Material : PLA
尺寸 Size : 193x127x15mm
數量 Quantity : 1000pcs
材積 Cu.ft. : 1.44'

**16**

材質 Material : PLA, PET
尺寸 Size : 218x153x18mm
數量 Quantity : 1000pcs
材積 Cu.ft. : 1.61'

**17**

材質 Material : PLA
尺寸 Size : 194x95x14mm
數量 Quantity : 2000pcs
材積 Cu.ft. : 1.57'

**25**

材質 Material : PLA
尺寸 Size : 155x123x31mm
數量 Quantity : 1200pcs
材積 Cu.ft. : 1.04'

**26S**

材質 Material : PLA, PET
尺寸 Size : 186x113x29mm
數量 Quantity : 1000pcs
材積 Cu.ft. : 1.54'

SUPERMARKET TRAY 托盤

**28**

材質 Material : PLA, PET
 尺寸 Size : 227x146x30mm
 數量 Quantity : 1000pcs
 材積 Cu.ft. : 2.49'

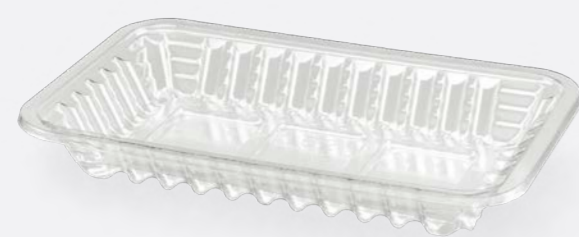
**62**

材質 Material : PLA, PET
 尺寸 Size : 205x130x29mm
 數量 Quantity : 1000pcs
 材積 Cu.ft. : 1.85'

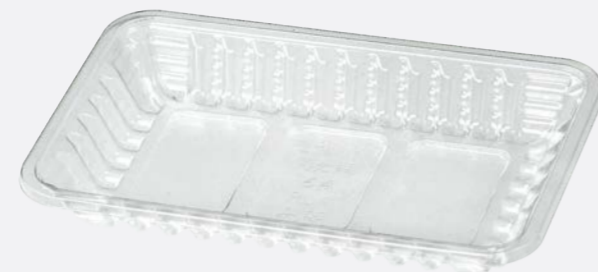
**64**

材質 Material : PLA, PET
 尺寸 Size : 217x138x29mm
 數量 Quantity : 1000pcs
 材積 Cu.ft. : 2.17'

**65**

材質 Material : PLA, PET
 尺寸 Size : 245x183x27mm
 數量 Quantity : 1000pcs
 材積 Cu.ft. : 3.41'

**504**

材質 Material : PLA
 尺寸 Size : 115x115x27mm
 數量 Quantity : 2000pcs
 材積 Cu.ft. : 1.15'

**T26**

材質 Material : PLA, PET
 尺寸 Size : 185x117x30mm
 數量 Quantity : 1000pcs
 材積 Cu.ft. : 1.25'

**T27**

材質 Material : PLA, PET
 尺寸 Size : 190x151x32mm
 數量 Quantity : 1000pcs
 材積 Cu.ft. : 1.62'

**T28**

材質 Material : PLA
 尺寸 Size : 248x159x32mm
 數量 Quantity : 1000pcs
 材積 Cu.ft. : 2.17'

**C-5000**

材質 Material : PET
 尺寸 Size : 268x220x35mm
 數量 Quantity : 600pcs
 材積 Cu.ft. : 7.2'

**C-7900**

材質 Material : PLA, PLA
 尺寸 Size : 311x261x75mm
 數量 Quantity : 300/300pcs
 材積 Cu.ft. : 5.72/2.92'

**A-019**

材質 Material : PLA
 尺寸 Size : 140x140x78mm
 數量 Quantity : 900pcs
 材積 Cu.ft. : 3.47'

**A-803**

材質 Material : PLA, PP
 尺寸 Size : 148x148x66mm
 數量 Quantity : 1000pcs
 材積 Cu.ft. : 3.85'

MULTI-CONTAINER SERIES 多用途容器

**C-002**

材質 Material : PP
 尺寸 Size : 243x221x134mm
 數量 Quantity : 200pcs
 材積 Cu.ft. : 3.24'

**C-003**

材質 Material : PP
 尺寸 Size : 278x198x30mm
 數量 Quantity : 400pcs
 材積 Cu.ft. :

**B-008**

材質 Material : PET
 尺寸 Size : 163x124x55mm
 數量 Quantity : 500sets
 材積 Cu.ft. : 6.02'

**KF-007**

材質 Material : PET
 尺寸 Size : 163x124x82mm
 數量 Quantity : 500sets
 材積 Cu.ft. : 6.02'

**LJ-001**

材質 Material : PLA
 尺寸 Size : 210x133x77mm
 數量 Quantity : 500pcs
 材積 Cu.ft. : 3.07'

**LJ-700**

材質 Material : PET
 尺寸 Size : 200x176x75mm
 數量 Quantity : 700pcs
 材積 Cu.ft. : 3.67'

**LJ-701**

材質 Material : PET/PET
 尺寸 Size : 202x176x59mm
 數量 Quantity : 500/500pcs
 材積 Cu.ft. : 3.77/4.48'

**LJ-1000**

材質 Material : PET/PET, PLA
 尺寸 Size : 248x187x74mm
 數量 Quantity : 600/600pcs
 材積 Cu.ft. : 8.74/3.25'

**S6**

材質 Material : OPS
 尺寸 Size : 230x150x35mm
 數量 Quantity : 500pcs
 材積 Cu.ft. : 1.50'

**S6-1**

材質 Material : OPS, PLA
 尺寸 Size : Ø213x41mm
 數量 Quantity : 500 pcs
 材積 Cu.ft. : 1.73'

**S6-2**

材質 Material : OPS/PLA, OPS
 尺寸 Size : Ø205x53mm
 數量 Quantity : 1000/1000pcs
 材積 Cu.ft. : 1.22/ 1.72'

**S6-3**

材質 Material : OPS, PET
 尺寸 Size : Ø200x36mm
 數量 Quantity : 1000pcs
 材積 Cu.ft. : 1.34'

**3.5Lid**

材質 Material : OPS
 尺寸 Size : 180x135x10mm
 數量 Quantity : 720pcs
 材積 Cu.ft. : 1.59'

FOOD CONTAINER SERIES 食品盒



FOOD CONTAINER SERIES 食品盒

**1H**

材質 Material : OPS, PET
尺寸 Size : 156x100x36mm
數量 Quantity : 2000pcs
材積 Cu.ft. : 1.96'

**1HC**

材質 Material : OPS
尺寸 Size : 153x100x36mm
數量 Quantity : 2000pcs
材積 Cu.ft. : 4.28'

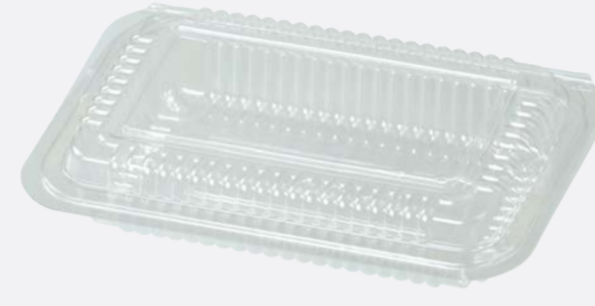
**1L**

材質 Material : OPS
尺寸 Size : 156x100x30mm
數量 Quantity : 2000pcs
材積 Cu.ft. : 1.96'

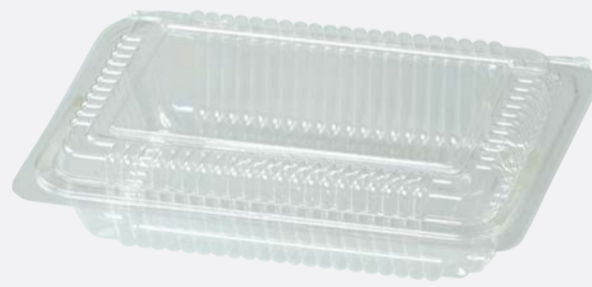
**2H**

材質 Material : OPS, PET
尺寸 Size : 164x112x37mm
數量 Quantity : 2000pcs
材積 Cu.ft. : 2.35', 2.63'

**2HC**

材質 Material : OPS
尺寸 Size : 161x113x37mm
數量 Quantity : 2000pcs
材積 Cu.ft. : 4.55'

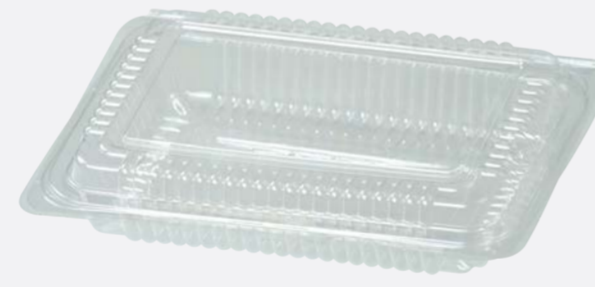
**2L**

材質 Material : OPS
尺寸 Size : 164x112x30mm
數量 Quantity : 2000pcs
材積 Cu.ft. : 2.35'

**3A**

材質 Material : OPS
尺寸 Size : 198x124x47mm
數量 Quantity : 2000pcs
材積 Cu.ft. : 3.13'

**3H**

材質 Material : OPS, PLA, PET
尺寸 Size : 199x127x37mm
數量 Quantity : 2000pcs
材積 Cu.ft. : 2.65', 3.59'

**3HC**

材質 Material : OPS, PLA
尺寸 Size : 195x127x37mm
數量 Quantity : 2000, 1000pcs
材積 Cu.ft. : 7.35', 4.14'

**3L**

材質 Material : OPS
尺寸 Size : 198x125x31mm
數量 Quantity : 2000pcs
材積 Cu.ft. : 2.65'

**5H**

材質 Material : OPS, PET
尺寸 Size : 201x140x43mm
數量 Quantity : 1000pcs
材積 Cu.ft. : 1.81'

**5HC**

材質 Material : OPS, PLA
尺寸 Size : 193x135x45mm
數量 Quantity : 1000, 400pcs
材積 Cu.ft. : 3.67', 2.14'

**5L**

材質 Material : OPS
尺寸 Size : 200x135x37mm
數量 Quantity : 1000pcs
材積 Cu.ft. : 1.81'

**6H**

材質 Material : OPS, PET, PLA
尺寸 Size : 218x149x47mm
數量 Quantity : 1000pcs
材積 Cu.ft. : 2.56'

**6L**

材質 Material : OPS
尺寸 Size : 218x149x37mm
數量 Quantity : 1000pcs
材積 Cu.ft. : 2.56'

**8H**

材質 Material : OPS, PET
尺寸 Size : 161x128x40mm
數量 Quantity : 2000pcs
材積 Cu.ft. : 2.65'

**9H**

材質 Material : OPS, PET
尺寸 Size : 188x122x19mm
數量 Quantity : 2000pcs
材積 Cu.ft. : 2.41'

**S1**

材質 Material : OPS
尺寸 Size : 274x158x30mm
數量 Quantity : 1000pcs
材積 Cu.ft. : 3.83'

**S3**

材質 Material : PET
尺寸 Size : 271x165x37mm
數量 Quantity : 500pcs
材積 Cu.ft. : 3.64'

**S4**

材質 Material : PET
尺寸 Size : 185x128x32mm
數量 Quantity : 1000pcs
材積 Cu.ft. : 1.65'



CFJ-3
 材質 Material : PP
 尺寸 Size : 196x79x25mm
 數量 Quantity : 2000pcs
 材積 Cu.ft. : 4.41'

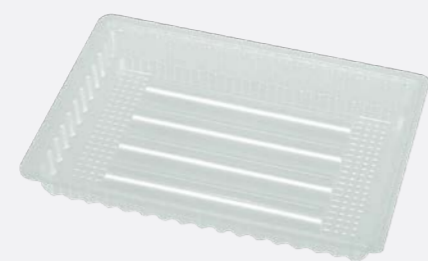

CFJ-5
 材質 Material : PP
 尺寸 Size : 206x146x25mm
 數量 Quantity : 1200pcs
 材積 Cu.ft. : 6.55'

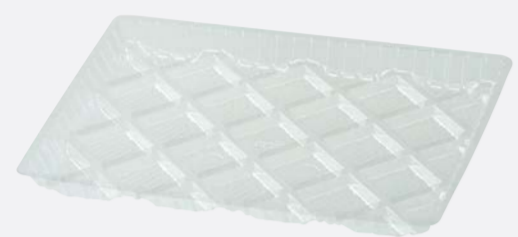

D07
 材質 Material : OPS
 尺寸 Size : 233x168x19mm
 數量 Quantity : 2000pcs
 材積 Cu.ft. : 2.74'



D08
 材質 Material : OPS, PET
 尺寸 Size : 168x118x12mm
 數量 Quantity : 4800pcs
 材積 Cu.ft. : 2.74'



D18
 材質 Material : OPS
 尺寸 Size : 245x168x18mm
 數量 Quantity : 2500pcs
 材積 Cu.ft. : 4.08'



D21
 材質 Material : OPS, PET
 尺寸 Size : 155x107x7mm
 數量 Quantity : 5000pcs
 材積 Cu.ft. : 3.50'



D22
 材質 Material : OPS
 尺寸 Size : 163x124x10mm
 數量 Quantity : 3500pcs
 材積 Cu.ft. : 2.74'

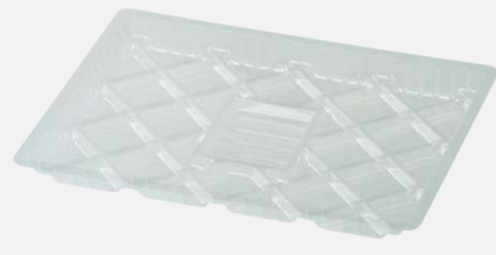

D23
 材質 Material : OPS, PET
 尺寸 Size : 253x186x20mm
 數量 Quantity : 1800,1600pcs
 材積 Cu.ft. : 2.74', 2.74'



D24
 材質 Material : OPS
 尺寸 Size : 238x157x30mm
 數量 Quantity : 3000pcs
 材積 Cu.ft. : 5.93'



D26
 材質 Material : OPS
 尺寸 Size : 230x208x16mm
 數量 Quantity : 1800pcs
 材積 Cu.ft. : 2.74'



D-102
 材質 Material : PET
 尺寸 Size : 266x200x9mm
 數量 Quantity : 1600pcs
 材積 Cu.ft. : 2.74'



D-106
 材質 Material : PET
 尺寸 Size : 199x135x8mm
 數量 Quantity : 4000pcs
 材積 Cu.ft. : 3.40'



K69
 材質 Material : OPS, PET
 尺寸 Size : 193x135x7mm
 數量 Quantity : 3500pcs
 材積 Cu.ft. : 1.74'

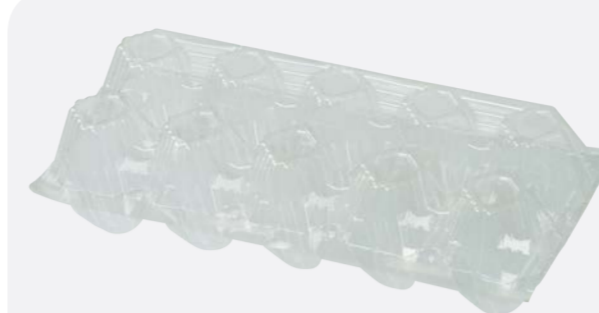

A1-10
 材質 Material : PLA, PET
 尺寸 Size : 234x109x66mm
 數量 Quantity : 2000pcs
 材積 Cu.ft. : 3.46'

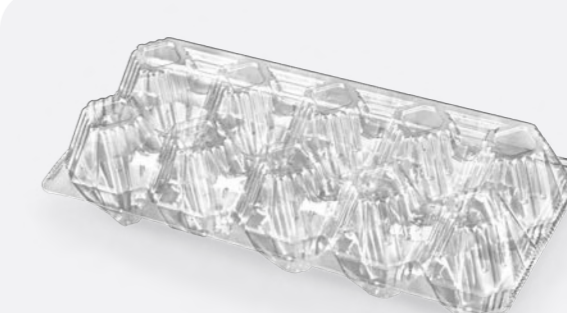

A1-10L
 材質 Material : PLA, PET
 尺寸 Size : 234x109x66mm
 數量 Quantity : 2000, 1600pcs
 材積 Cu.ft. : 3.12'

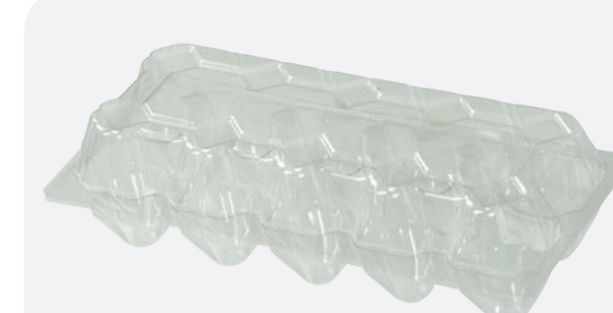

A1-10P
 材質 Material : PLA
 尺寸 Size : 247x110x68mm
 數量 Quantity : 1000pcs
 材積 Cu.ft. : 3.43'

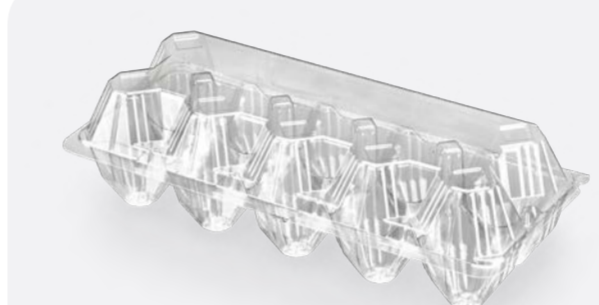

A1-10P2
 材質 Material : PLA
 尺寸 Size : 242x105x70mm
 數量 Quantity : 1000pcs
 材積 Cu.ft. : 3.20'

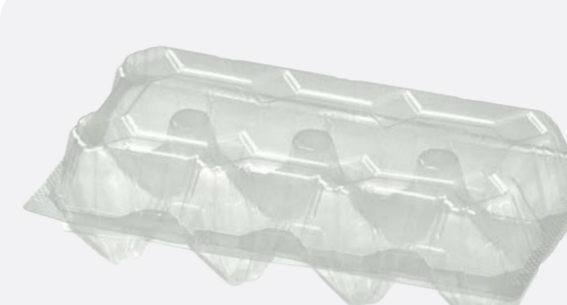

A1-8P
 材質 Material : PLA
 尺寸 Size : 228x110x66mm
 數量 Quantity : 1200pcs
 材積 Cu.ft. : 3.02'



A1-6P
 材質 Material : PLA
 尺寸 Size : 155x106x66mm
 數量 Quantity : 2000pcs
 材積 Cu.ft. : 2.54'

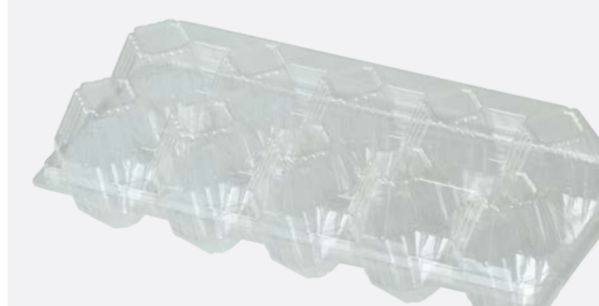

A2-10
 材質 Material : PLA, PET
 尺寸 Size : 240x108x68mm
 數量 Quantity : 1200pcs
 材積 Cu.ft. : 3.73'

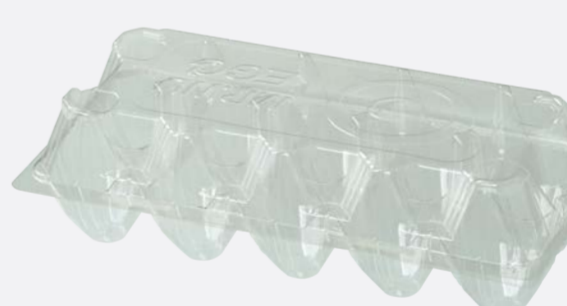

A2-10P
 材質 Material : PLA, PET
 尺寸 Size : 240x108x67mm
 數量 Quantity : 1000, 800pcs
 材積 Cu.ft. : 3.21', 3.21'

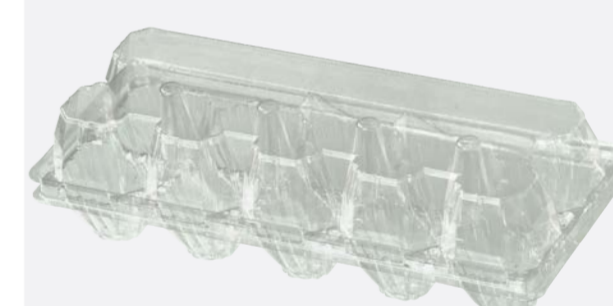

A2-10PC
 材質 Material : PLA
 尺寸 Size : 249x105x66mm
 數量 Quantity : 800pcs
 材積 Cu.ft. : 6.39'

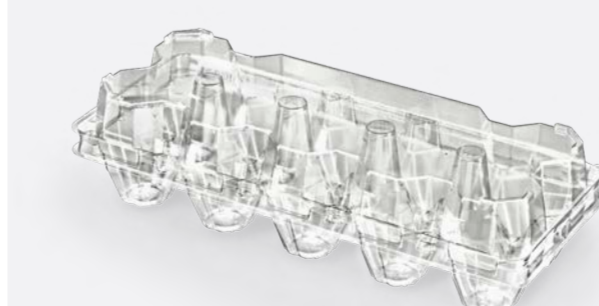

A2-10PCS
 材質 Material : PLA, PET
 尺寸 Size : 243x101x64mm
 數量 Quantity : 700pcs
 材積 Cu.ft. : 6.39'

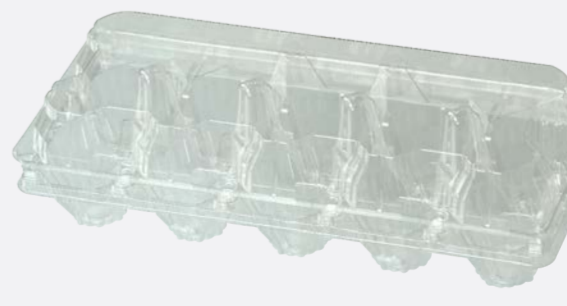

A2-10PJ
 材質 Material : PLA, PET
 尺寸 Size : 249x105x66mm
 數量 Quantity : 600pcs
 材積 Cu.ft. : 6.39'

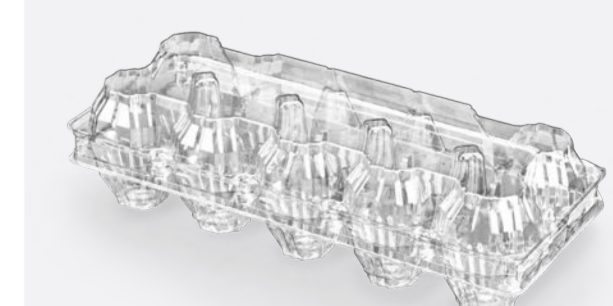

A2-10PJW
 材質 Material : PLA, PET
 尺寸 Size : 249x105x66mm
 數量 Quantity : 600pcs
 材積 Cu.ft. : 6.39'

EGG CONTAINER SERIES 蛋盒

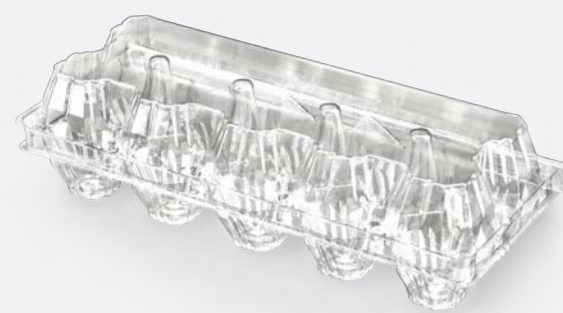
**A2-10PJX**

材質 Material : PLA, PET
 尺寸 Size : 245x105x72mm
 數量 Quantity : 600pcs
 材積 Cu.ft. : 6.39'

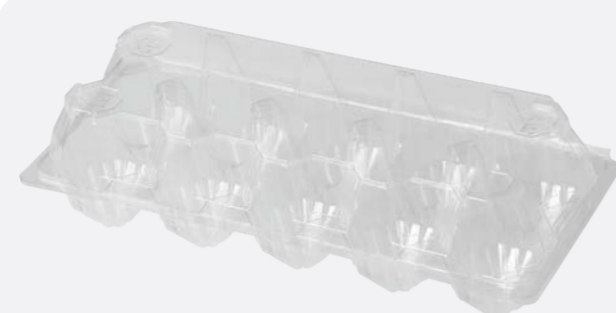
**A2-10PX**

材質 Material : PLA, PET
 尺寸 Size : 248x108x68mm
 數量 Quantity : 800pcs
 材積 Cu.ft. : 3.09'

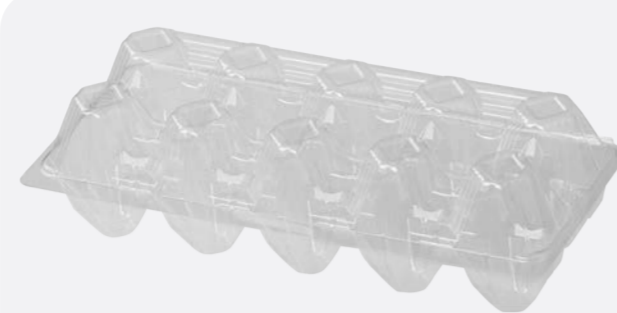
**A2-10X**

材質 Material : PLA, PET
 尺寸 Size : 248x108x70mm
 數量 Quantity : 1000pcs
 材積 Cu.ft. : 4.96'

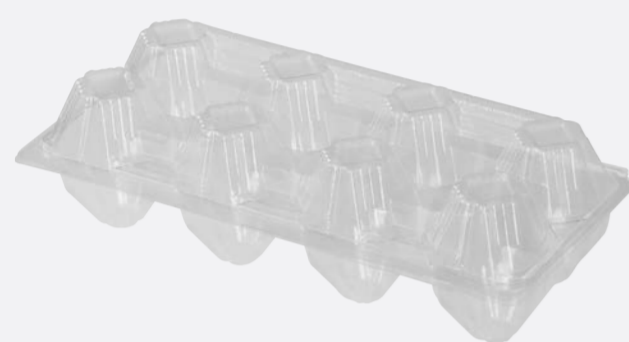
**A2-8**

材質 Material : PLA
 尺寸 Size : 240x108x67mm
 數量 Quantity : 1000pcs
 材積 Cu.ft. : 2.93'

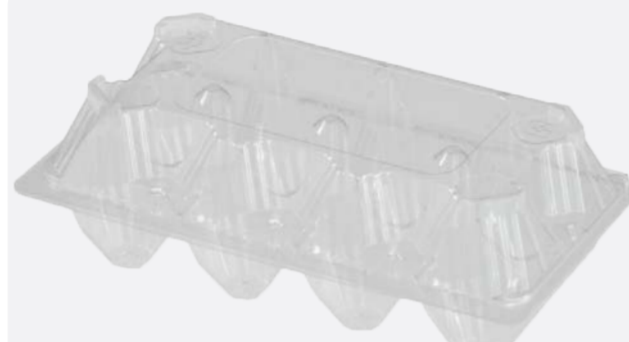
**A2-8P**

材質 Material : PLA
 尺寸 Size : 202x108x73mm
 數量 Quantity : 1000pcs
 材積 Cu.ft. : 5.74'

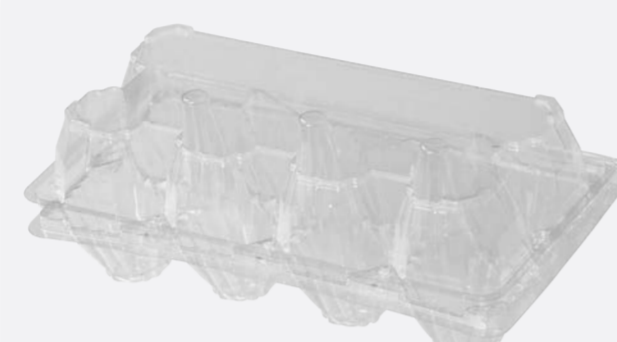
**A2-8PC**

材質 Material : PLA
 尺寸 Size : 201x105x66mm
 數量 Quantity : 1000pcs
 材積 Cu.ft. : 6.28'

**A2-8PCS**

材質 Material : PLA, PET
 尺寸 Size : 195x98x60mm
 數量 Quantity : 1200, 1000pcs
 材積 Cu.ft. : 5.99'

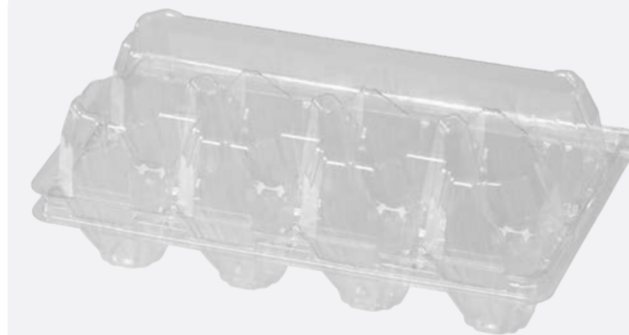
**A2-8PCX**

材質 Material : PLA, PET
 尺寸 Size : 207x106x66mm
 數量 Quantity : 800pcs
 材積 Cu.ft. : 6.28'

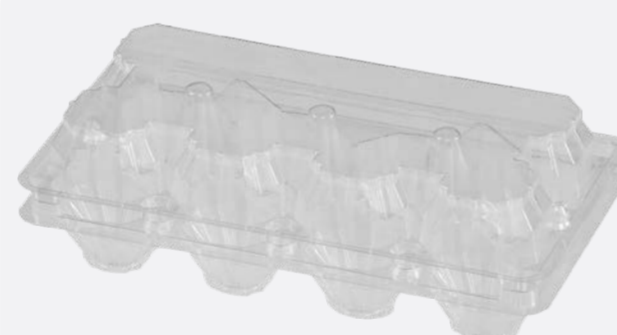
**A2-8PJ**

材質 Material : PLA, PET
 尺寸 Size : 202x103x65mm
 數量 Quantity : 700pcs
 材積 Cu.ft. : 6.28'

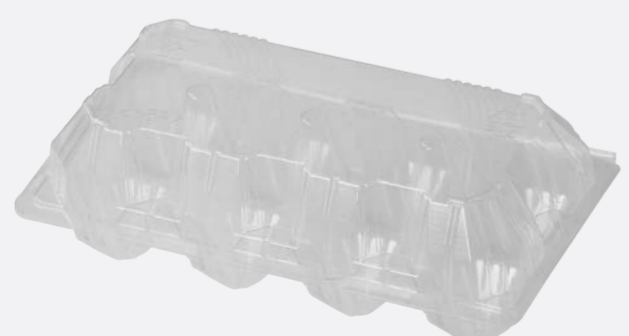
**A2-8PX**

材質 Material : PLA
 尺寸 Size : 207x108x68mm
 數量 Quantity : 1000pcs
 材積 Cu.ft. : 3.55'

**A2-6**

材質 Material : PLA, PET
 尺寸 Size : 145x108x63mm
 數量 Quantity : 2000, 1600pcs
 材積 Cu.ft. : 2.74'

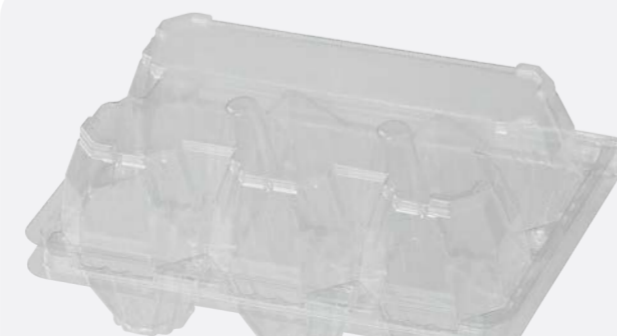
**A2-6PC**

材質 Material : PLA
 尺寸 Size : 154x105x66mm
 數量 Quantity : 1000pcs
 材積 Cu.ft. : 4.87'

EGG CONTAINER SERIES 蛋盒

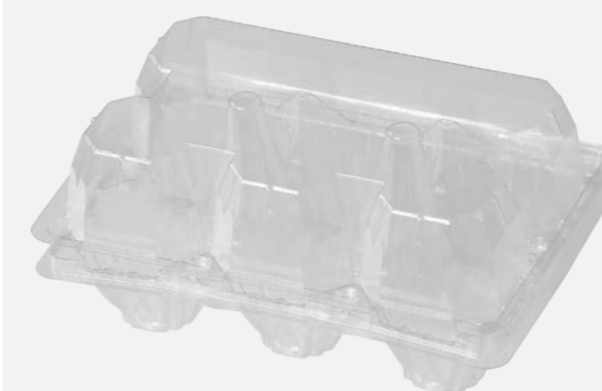
**A2-6PCX**

材質 Material : PLA
 尺寸 Size : 159x107x70mm
 數量 Quantity : 1000pcs
 材積 Cu.ft. : 4.86'

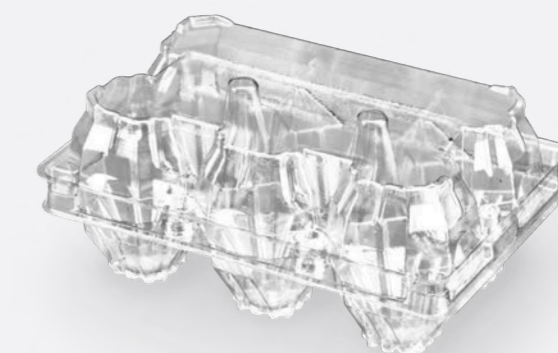
**A2-6PJ**

材質 Material : PLA, PET
 尺寸 Size : 150x103x44mm
 數量 Quantity : 700pcs
 材積 Cu.ft. : 4.68'

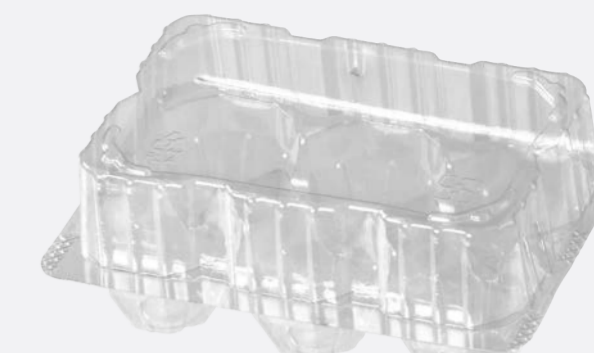
**A3-6PX**

材質 Material : PLA, PET
 尺寸 Size : 153x110x65mm
 數量 Quantity : 2000pcs
 材積 Cu.ft. : 6.10'

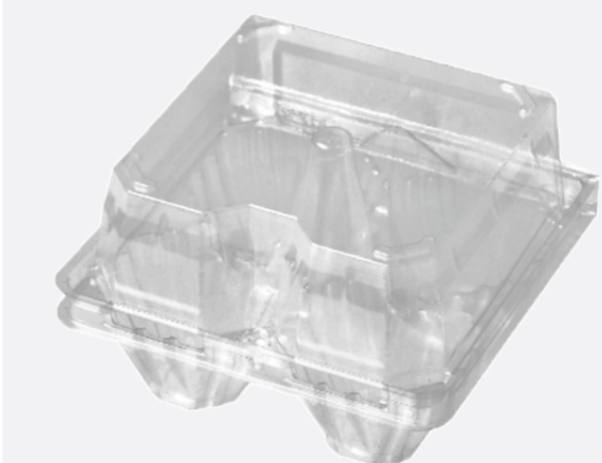
**A2-4PC**

材質 Material : PLA
 尺寸 Size : 107x107x70mm
 數量 Quantity : 1000pcs
 材積 Cu.ft. : 3.29'

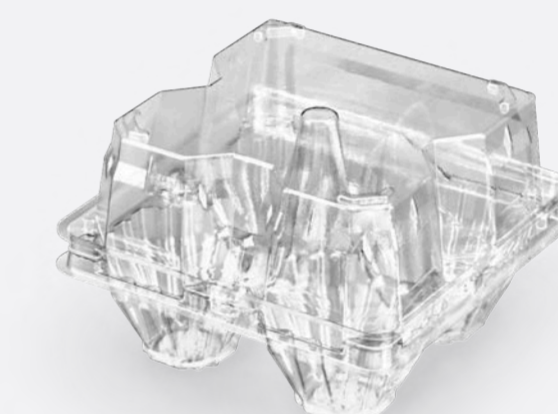
**A2-4PC-3扣**

材質 Material : PLA
 尺寸 Size : 107x107x70mm
 數量 Quantity : 1000pcs
 材積 Cu.ft. : 3.29'

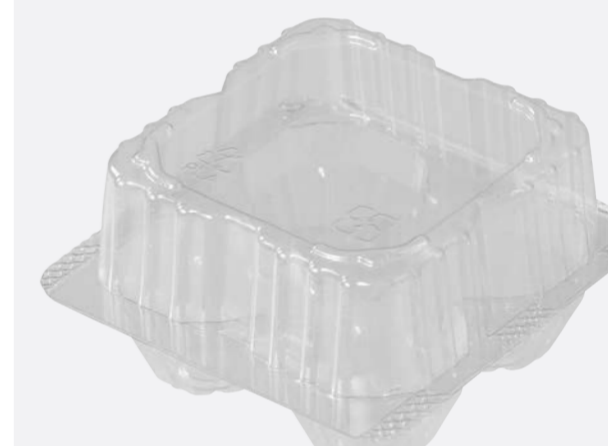
**A3-4PX**

材質 Material : PLA, PET
 尺寸 Size : 114x108x65mm
 數量 Quantity : 2100, 1800pcs
 材積 Cu.ft. : 5.01'

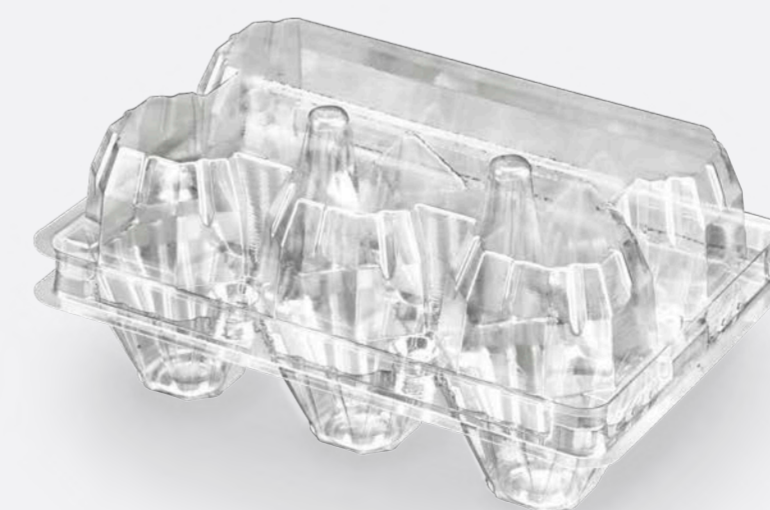
**A2-6PJX**

材質 Material : PLA, PET
 尺寸 Size : 157x108x71mm
 數量 Quantity : 700pcs
 材積 Cu.ft. : 4.86'

**A3-30C**

材質 Material : PLA
 尺寸 Size : 295x306x70mm
 數量 Quantity : 150pcs
 材積 Cu.ft. : 5.42'



CCI[®]

金新工業股份有限公司
CHEN'S CONTAINER INDUSTRIAL CORP.

台中市清水區東山里神清路40-9號
TEL: +886-04-2620-2448 (代表號)
FAX: +886-04-2620-2753
<http://www.ccicorp.com.tw>

No. 40-9, Shenqing Rd., Qingshui Dist.,
Taichung City 436, Taiwan (R.O.C.)
E-MAIL : info@ccicorp.com.tw



HACCP



ISO 22000



Food Safety Management
FC004